



LITTLE BIG IDEAS



Une agence de publicité qui apporte des solutions créatives et technologiques pour réveiller votre business. Depuis février 2023, Jill est certifiée en éco-conception de service numérique.

✔ Nous croyons aux idées seulement si elles sont efficaces.

PULP

DEVENEZ IRRÉSISTIBLE

Développez votre notoriété en nous confiant la création de votre identité.

Nous travaillons autour de vos valeurs et de ce qui vous rend unique pour créer votre logo et un territoire de marque qui ne laissera jamais personne indifférent.

BR / BRANDING

TM / TERRITOIRE DE MARQUE

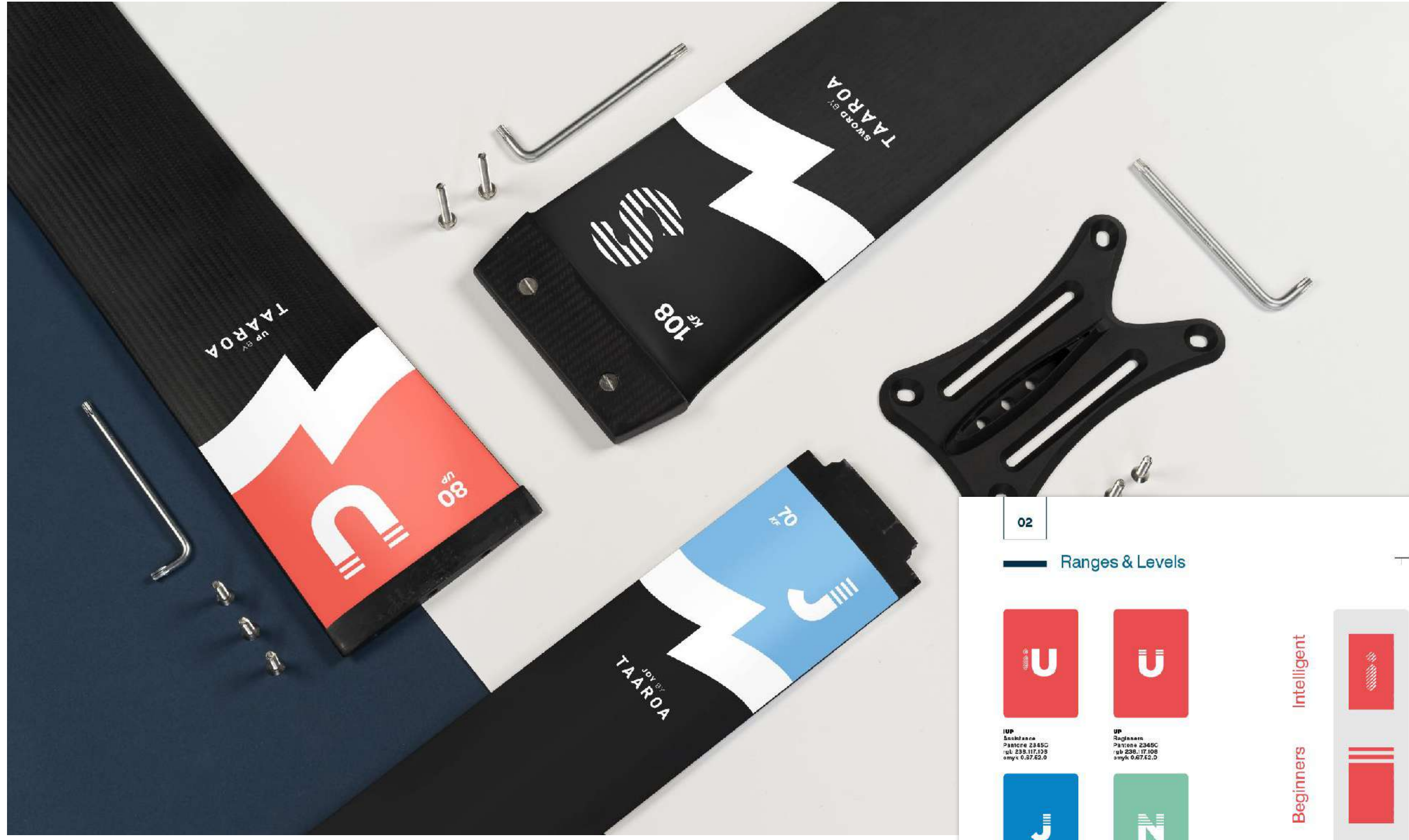

CLIENT /
Taaroa, Nouvelle génération d'hydrofoils.

BRIEF /
 Refonte totale de la marque.

LA RÉALISATION /
 Rebranding, création de nouveaux produits, charte graphique, illustrations techniques et contenus sociaux.

02 Ranges & Levels

U	U
UP Sculpture Platine 2345G pL 23 177.09 mkg 0.8742.0	UP Regimes Platine 0349C pL 206. 17.99 mkg 0.8742.0
J	N
JBY Cockpit Platine P1001 Blue G pL 2 033.201 mkg 007.21.2	NOE Cockpit Platine 2349C pL 200. 17.99 mkg 0.8742.0
S	N
SWORD Sword Platine Hawk X.C pL 40.45.29 mkg 16.521.50	NOE UHM Sword Platine Hawk X.C pL 40.45.29 mkg 16.521.50

Intelligent
 Beginners
 Confirmed
 Experts

03 Key Features Icons

PLATE MOUNT	V-FIX SYSTEM	ALUMINIUM
ANTI STALL SHAPE	POWER BOX	HD
DEEP TUTTLE BOX	UNDOX	HYBRID
EA BETTING	QUICK PRECISE	TITANIUM
HAT	TITANIUM WASHERS REINFORCEMENT	UHM
HELIDIP	SKM	SWM

03 Materials

Fig 11	22 Ti Titanium 47.88	
Fig 12	6 C UHM Carbon 12.01	
Fig 13	6 C HYBRID Carbon 12.01	
Fig 14	6 C HR Carbon 12.01	
Fig 15	13 Ai Aluminium 26.982	

ANTI STALL SHAPE

QUICK PRECISE

HELIDIP

Fig 01

Fig 02

Fig 03

A1

06 Using the foil.

03 Position

The Quick N' Precise system allows you to adjust the stabilizer's angle and incline. Below are the settings we recommend depending on your desired performance.

	Front	Center	Rear
	More stability Less maneuverability	Neutral	Less stability More maneuverability

Fig 01

A1

03 Components.

01 Description

A5



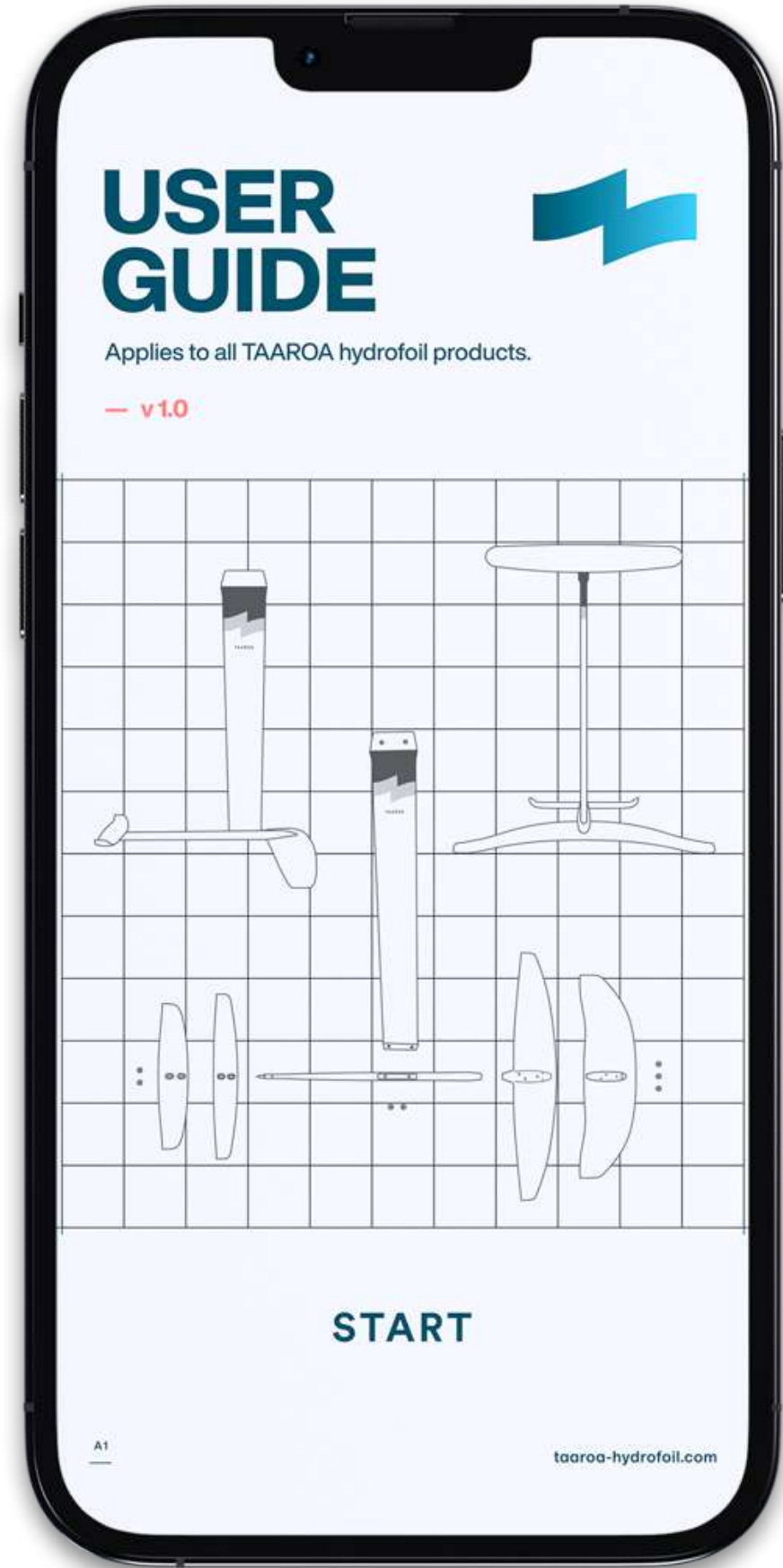

08 Products Stickers

LETTRÉ GOTHAM BLACK
108
KF

CHIFFRE HELVETICA NOW EXTRA BOLD

TYPOGRAPHIES

INITIALES HELVETICA NOW EXTRA BOLD ITALIC

108 UHM SWORD

SWORD 108 UHM

09 Wings Range.

LOW ASPECT

700 ^{CM²}	800 ^{CM²}	900 ^{CM²}	1250 ^{CM²}	1600 ^{CM²}	2000 ^{CM²}
HYBRID BODY	HYBRID BODY	HYBRID BODY	HYBRID BODY	HYBRID BODY	HYBRID BODY

HIGH ASPECT

520 ^{CM²}	550 ^{CM²}	600 ^{CM²}	700 ^{CM²}	1050 ^{CM²}	1450 ^{CM²}
HYBRID BODY	HYBRID BODY	HYBRID BODY	HYBRID BODY	HYBRID BODY	HYBRID BODY

2000^{CM²}

HYBRID 100CM

CARBON

Front wing 1450 Rear wing 300

09 Boards design.

1350

Black

Pantone 31C

TAAROA

PEAK 130

PEAK 142

A1

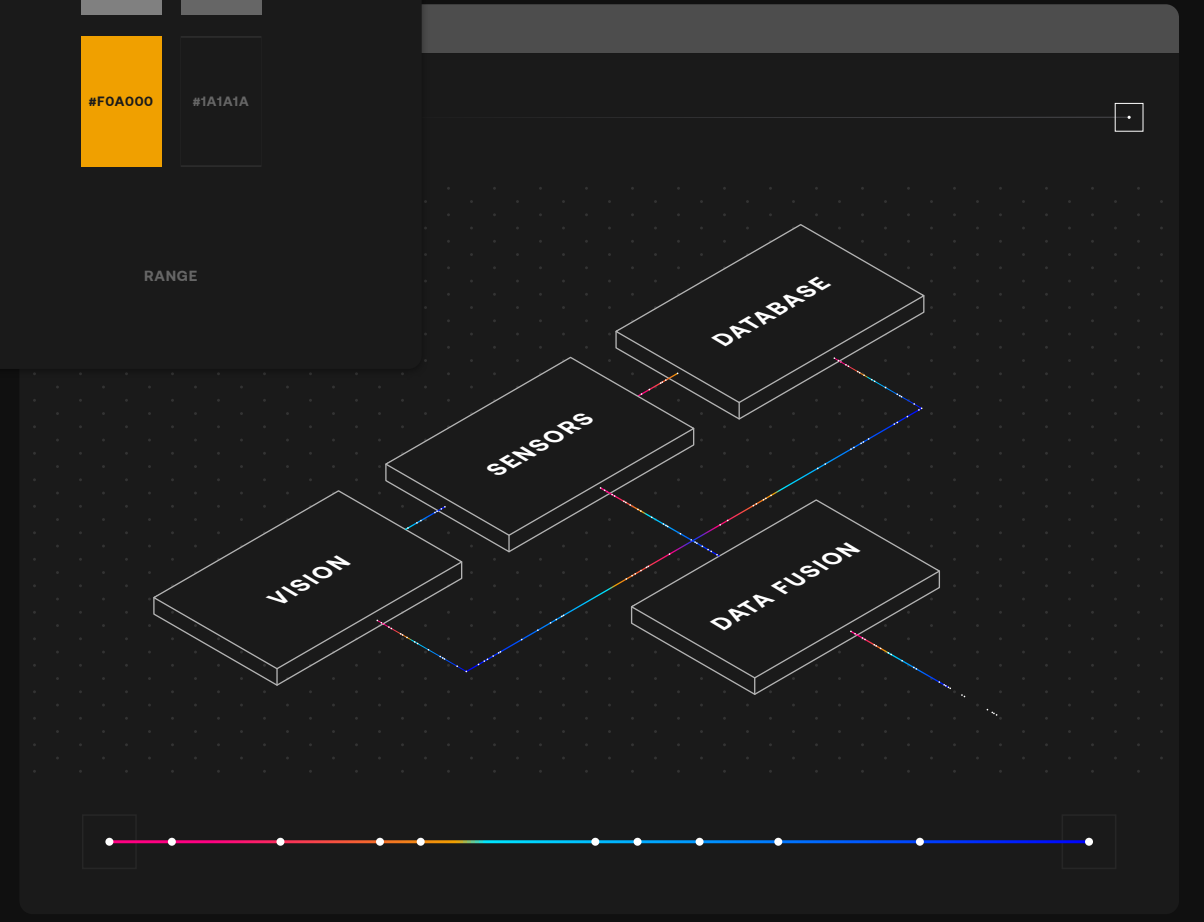
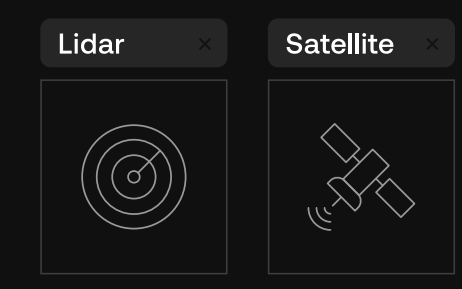
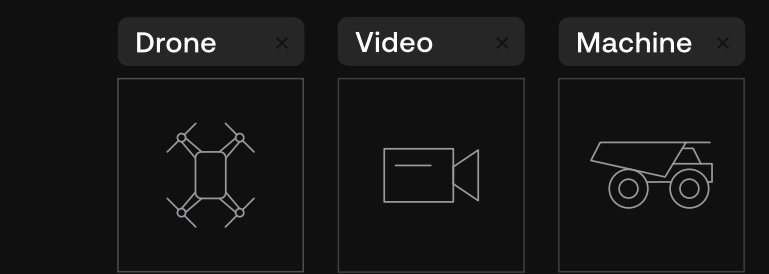
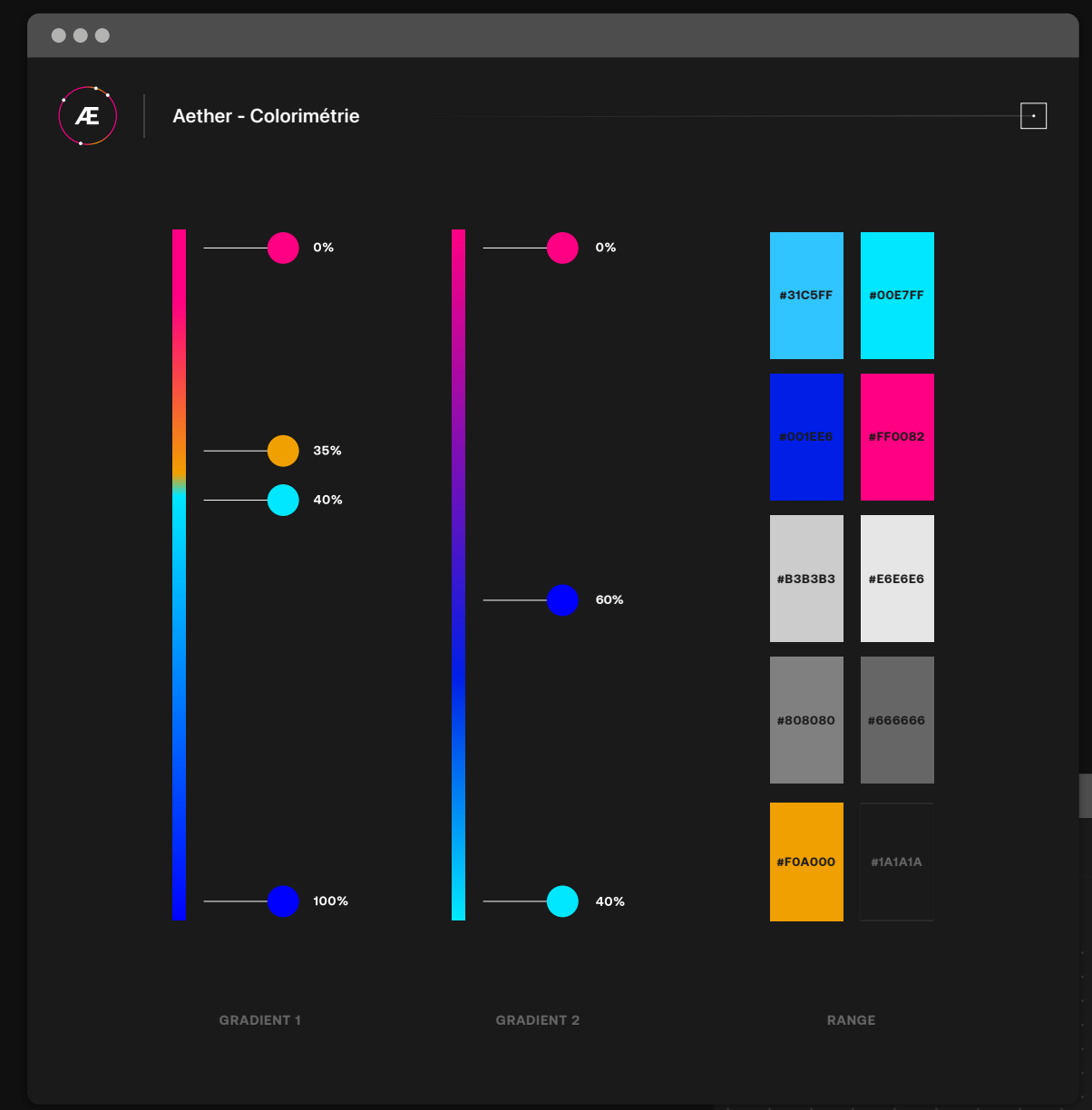
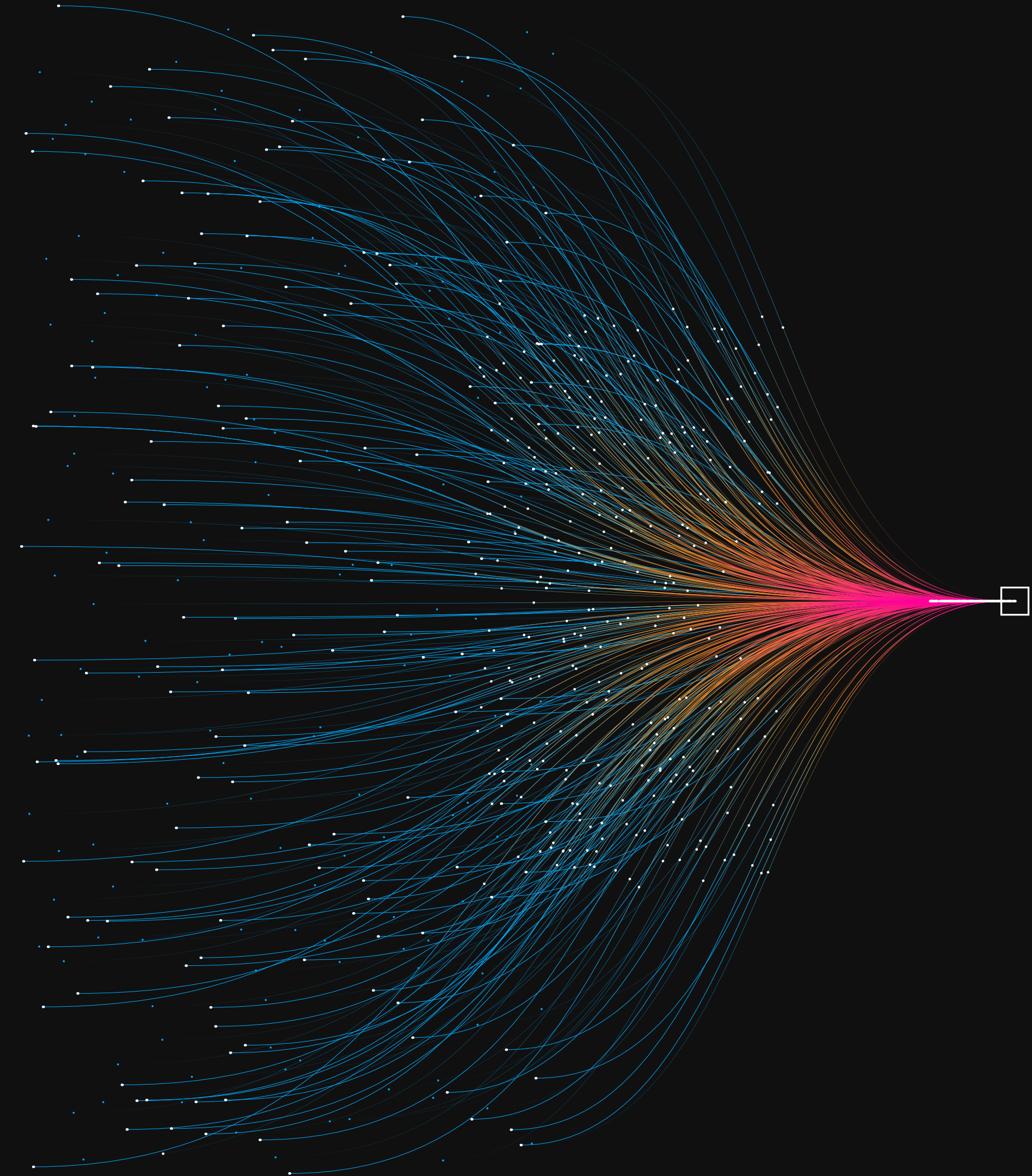

CLIENT /
Æther, La plateforme d'Alteia.

BRIEF /
 Création d'une nouvelle marque pour Alteia.

LA RÉALISATION /
 Un territoire de marque hyper riche qui se déploie en illustration et en animation 3D, pour le print et le web.

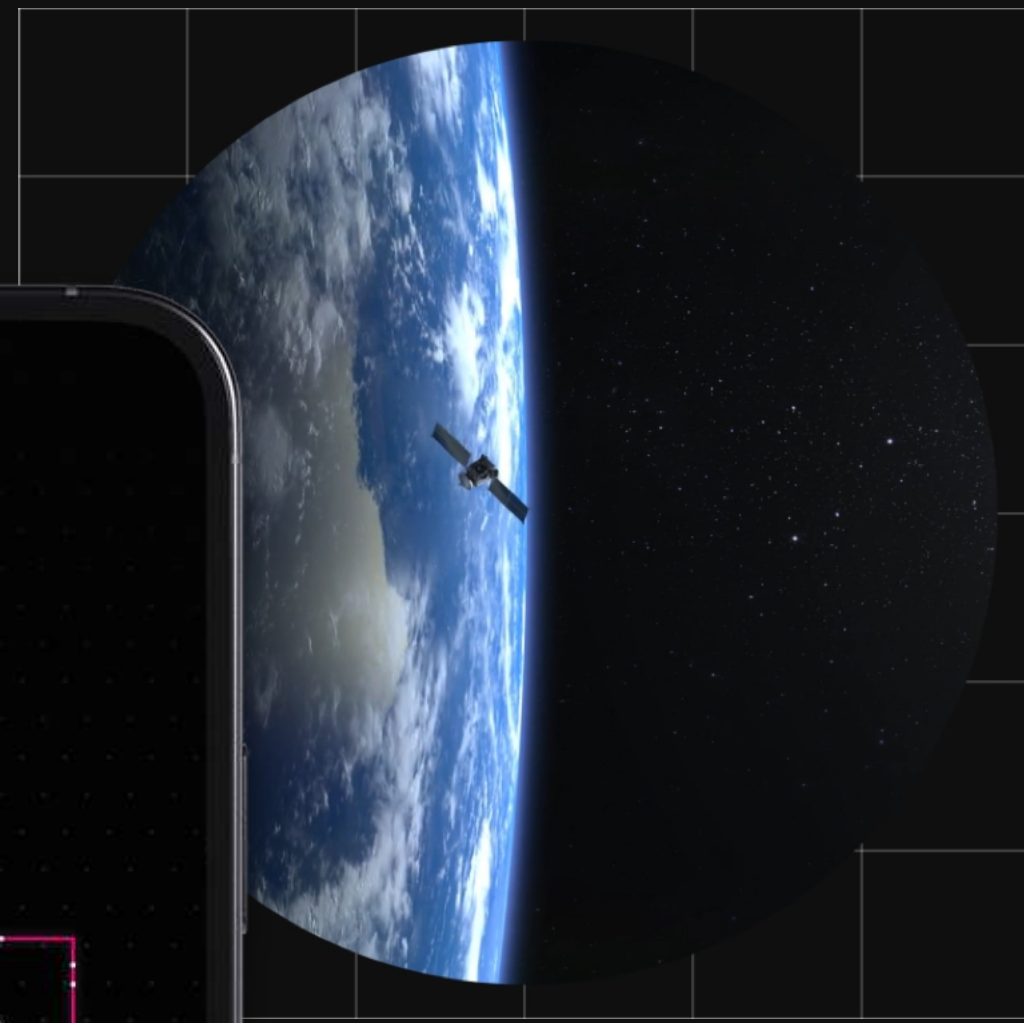

Airborne vision system

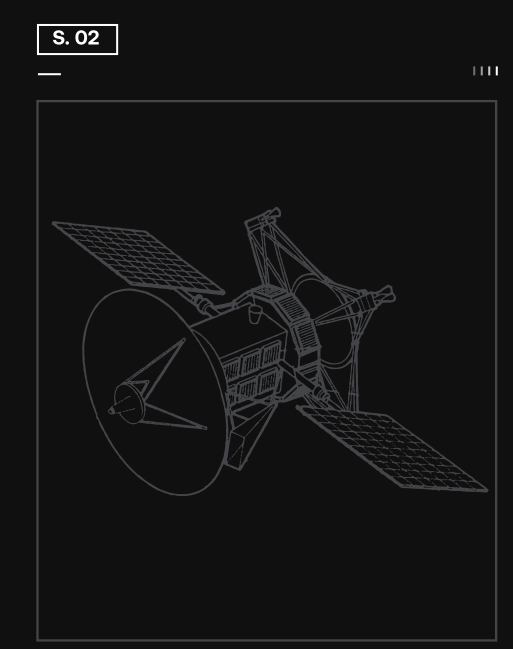

- SATELLITE
RGB, multispectral, SAR
- DRONE
RGB, multispectral, hyperspectral, Lidar, thermal
- MOBILE MAPPING SYSTEM
RGB, 360 image, Lidar, video
- LASER SCANNER
Lidar
- ROBOT
Lidar, thermal, video, image

Grid

↑ Outage risk +18%
 ↑ Open work orders +37%

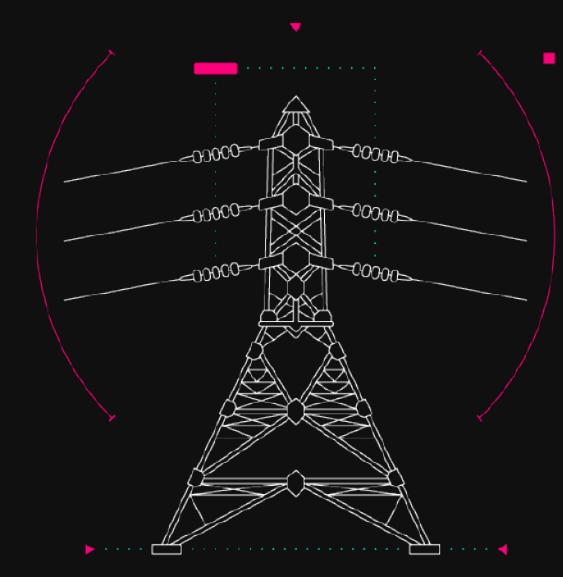

Manufacturing

↑ Throughput +24%
 ↓ Anomaly detection -18%

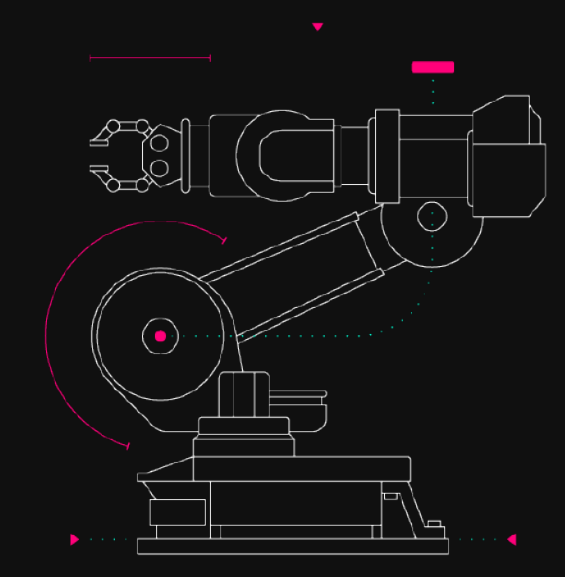

Infrastructure

↑ Resilience assessment +30%
 ↑ Renovation costs +27%

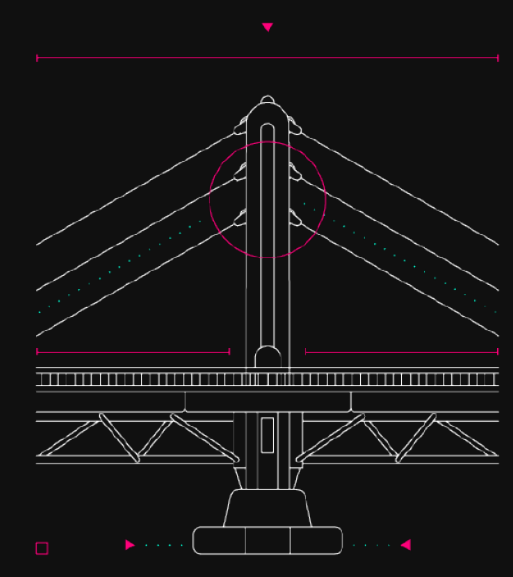

03.
NEW REPORT

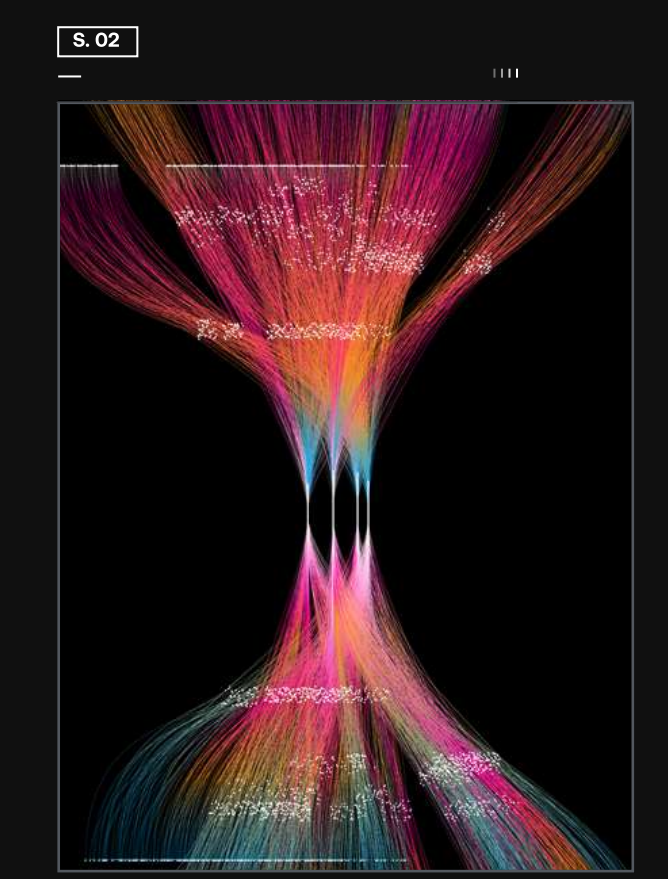
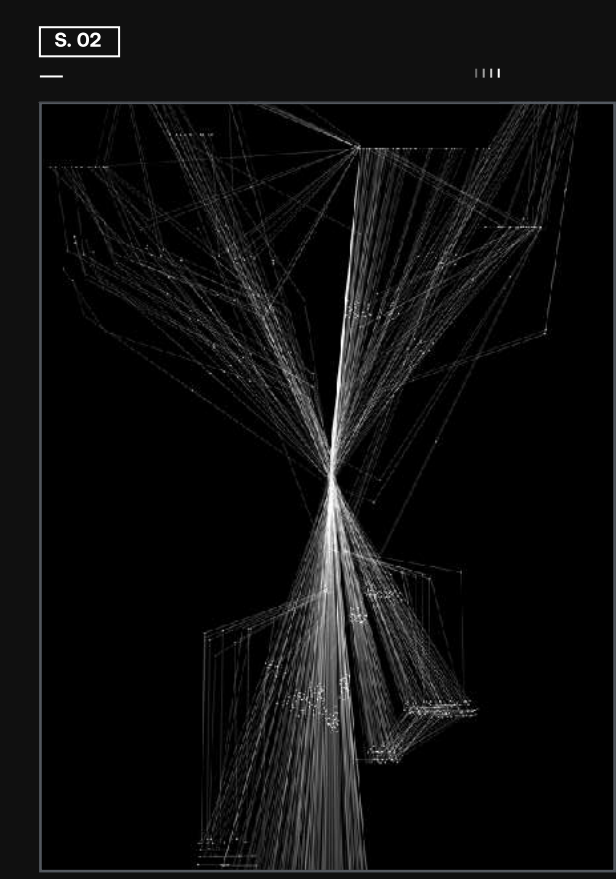
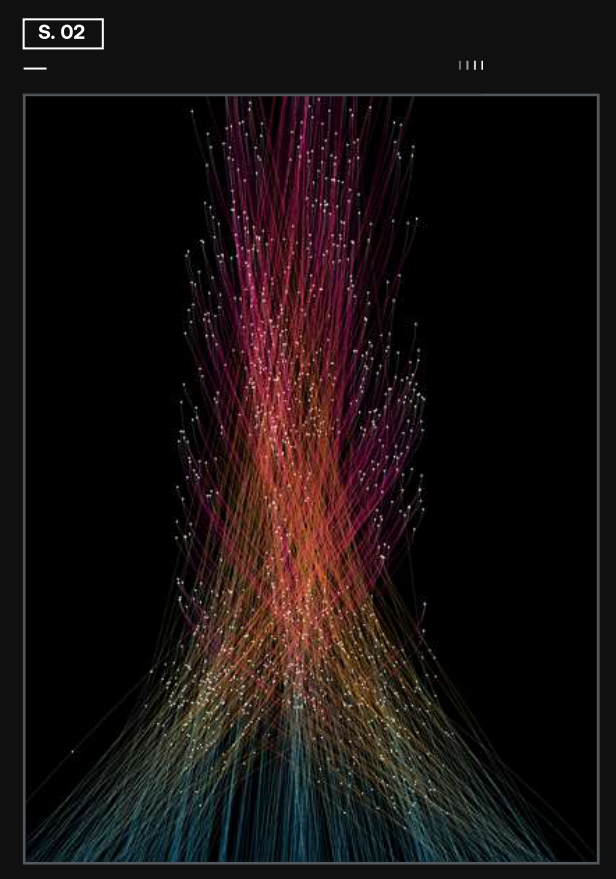

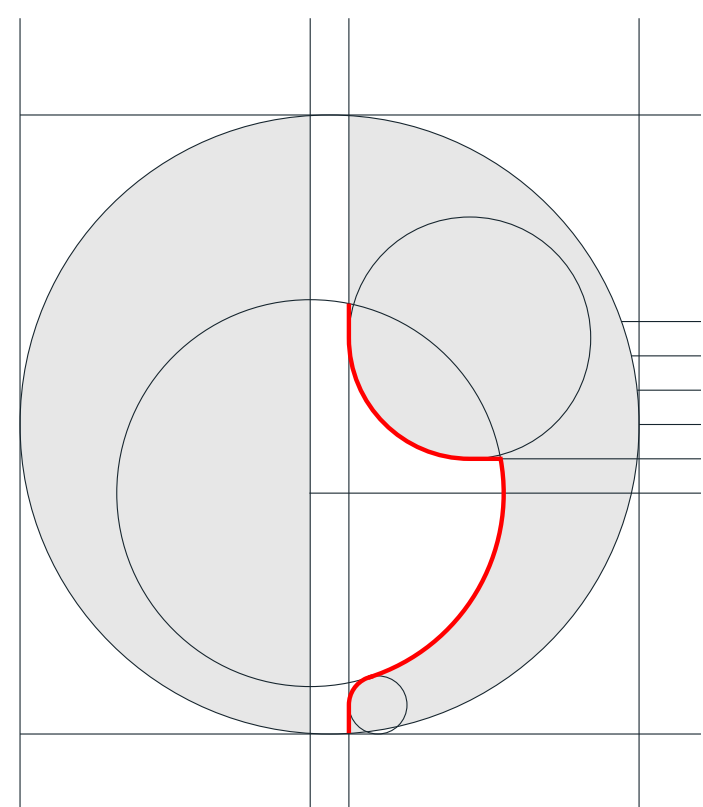

CLIENT /
Comme un Éléphant, Porcelaine de Limoges.

BRIEF /
Création d'une nouvelle marque de porcelaine haut de gamme.

LA RÉALISATION /
Un logo ultra minimaliste décliné en monogramme et en estampille pour répondre aux contraintes de l'impression céramique. Lancement prévue début 2024 !



Estampille Made in France



Estampille porcelaine



CLIENT /
Vivoka, L'IA vocale embarquée.

BRIEF /
Territoire de marque et charte graphique.

LA RÉALISATION /
Création de l'onde Vivoka et définition
de tous les assets de communication de la marque.

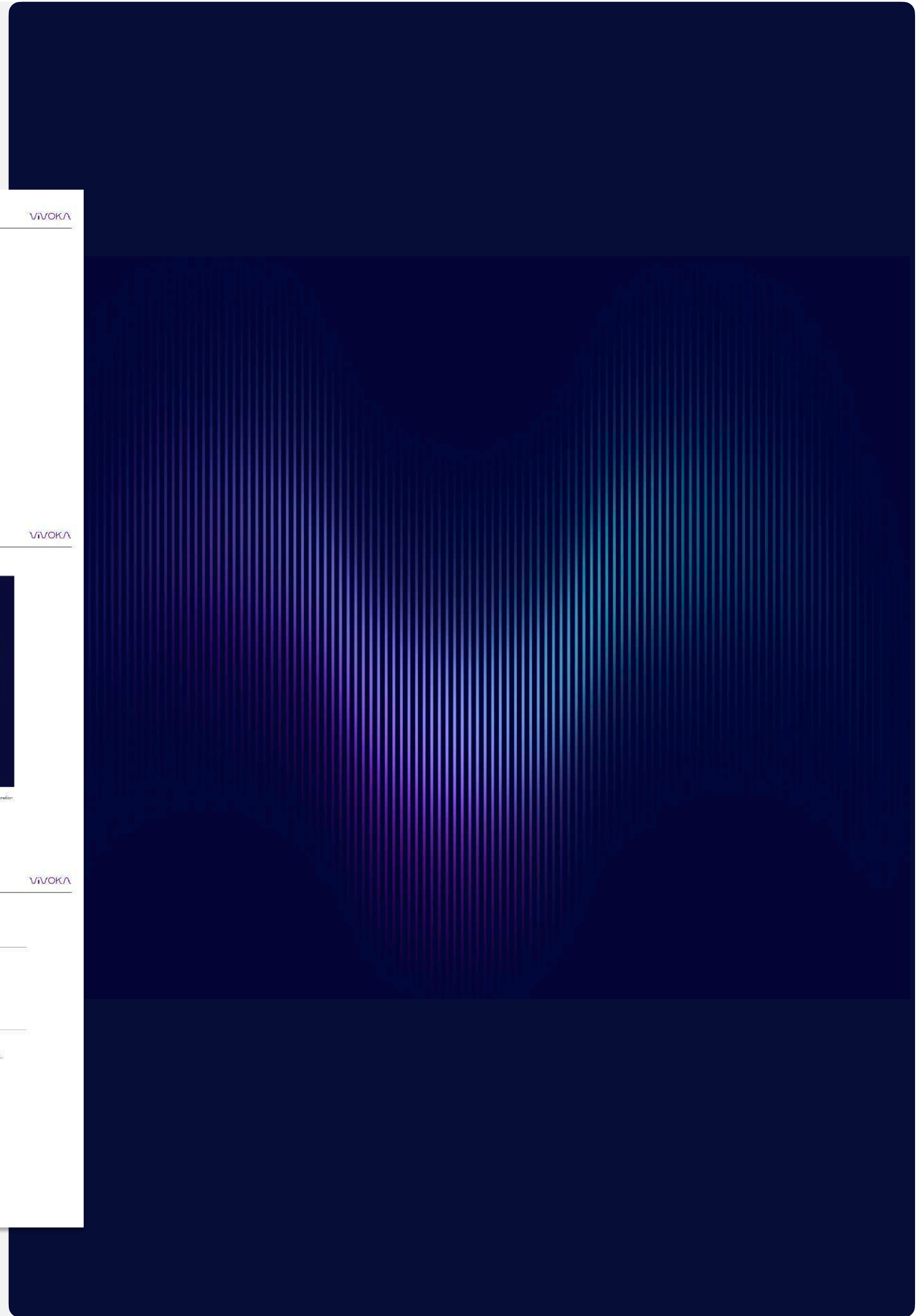
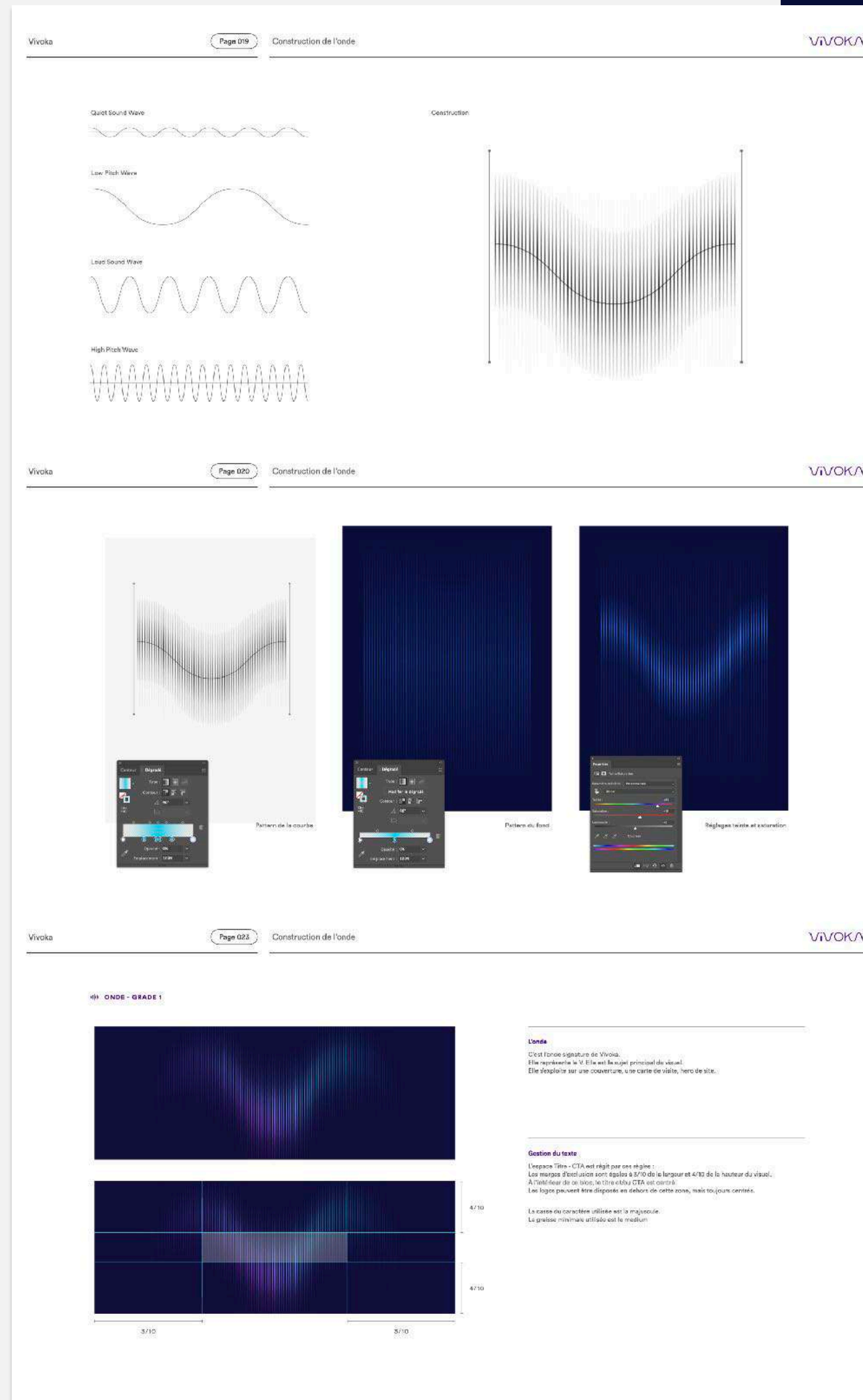
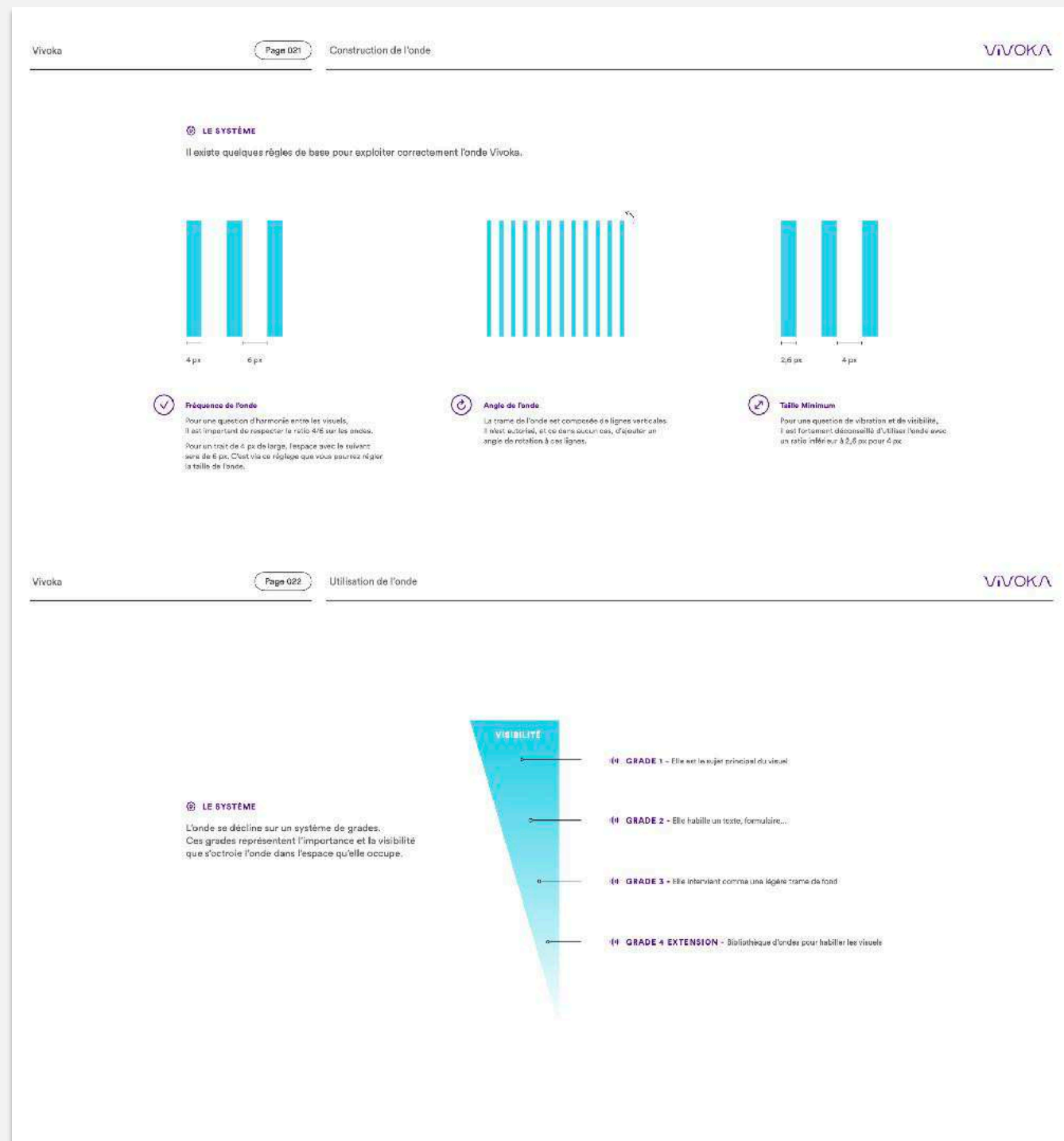

En bref,

PLANNING STRATÉGIQUE	PS	Positionnement de marque - Recommandation stratégique - Audit et analyse concurrentielle
DIRECTION ARTISTIQUE	DA	Branding - Charte graphique - Contenus pour les réseaux sociaux - Campagne de pub
CONCEPTION RÉDACTION	CR	Naming - Signature de marque - Script - Spots radio - Campagne de pub
COMMUNITY MANAGEMENT	CM	Ligne éditoriale - Rédaction - Publication - Modération - Campagne média
RÉDACTION	RE	Contenus web - Enrichissement et optimisation seo
UI & UX DESIGN	UX	Wireframes - Design sites et applications mobiles
DÉVELOPPEMENT WEB	DEV	Wordpress - Drupal - Odoo - Html/CSS/SaaS - NodeJS - Symfony - Laravel - Ionic - Angular - React
ÉCO-CONCEPTION WEB	ECO	Conception responsable pour une réduction des impacts environnementaux



43 rue de la Course 33300 Bordeaux
agencejill.fr